

FTU (Feeder Terminal Unit)

for Distribution Automation

BF2-1F

Pole-mounted Load Break Switch Control

BF2-1D

Automatic Circuit Recloser Control

BF2-1M

Automatic Circuit Recloser Control(Permanent magnet)



Our high technology doesn't allow even 1% tolerance of error.

Zhuhai Gopower Smart Grid Co., Ltd. was founded in 1998. It is one of the earliest high-tech companies engaged in the R&D and production of (12KV-40.5kV) medium-voltage transmission and distribution intelligent control equipment in China. It is one of the initiators and members of the Zhuhai Smart Grid Alliance. After 15 years of painstaking exploration and development, the company has grown into a leading enterprise in the field of smart power transmission and distribution in China.

We are committed to the construction of distribution networks.

Gopower attaches great importance to the improvement of enterprise research and development capabilities. Every year, no less than 8% of the annual sales revenue is invested in product research and development, with R&D technical personnel accounting for more than 30% of the total number of employees in the company. Conduct research on the application and future direction of products in the field of intelligent distribution networks. Our 11 kV Load Break Switch, 15 kV Automatic Circuit Recloser, feeder terminal units, and other pole mounted circuit breakers are always committed to providing customers with stable and reliable intelligent distribution network overall solutions.





Contents

- 04 Introduction, Key Features
- 05 Features
- 07 Technical Data
- 10 General Specifications
- 12 Communication Interface, Communication Interface
- 13 Outline & Dimension, Enclosure Dimensional Drawings
- 14 FTU Interface Connectors, Construction
- 15 External Connections

BF2 series

Introduction

FTU is a remote terminal unit for distribution automation which controls and monitors switches on the distribution lines such as Load Break Switch, Recloser, or RMU (Ring Main Units) and measures various electrical quantities of the line and transmits data to control center through remote communication.

The BF2 series is a new type of high-voltage switch control device that combines high-speed DSP and high-performance ARM chips. It integrates functions such as protection, measurement, control, monitoring, communication, and remote control, with high integration, flexible configuration, and user-friendly interface.



Automatic Circuit Recloser、 Load Break Switch Control

Key Features

- Integrated multi-functions on new microprocessor based platform - Fault detection & Protection, Metering, Control, Status monitoring, Power quality monitoring.
- Directional protection, Negative sequence protection, SEF and lots of built-in over-current protection curves including IEC,ANSI, Recloser curves.
- 4 setting groups and automatic setting group change function.
- 4 quadrants energy metering & load profiling.
- Multi-port, multi-protocol communication support (DNP3.0, DNP3.0 over TCP/IP, IEC60870-5-101/104),modem control for SCADA.
- DNP3.0 subset level 3 with information index mapping & class assignment.
- Built-in protocol monitor for integrating FTU with DAS system.
- Large size memory for load profiling, event and fault recording. Available Disturbance waveforms with COMTRADE format.
- Configurable digital inputs.
- Intelligent power supply & battery charger with built-in self-diagnosis & test function.
- Easy maintenance through separated module design with simple CAN interface.
- IP54 enclosure for mounting on the pole-top
- Type tested in accordance with IEC60265-1 and IEEE Std. C37.60
- Customized supports for special user-required functions and firmware upgradable at site.

Features

■ Hardware

RTU

- Dual Processor : ARM9 + DSP
- 16-bit A/D converter
- Non-volatile memory : FRAM(1 Mbytes),Flash ROM (1 Mbytes)
- HMI : LCD 20 characters * 8 lines with LED backlight, Buttons, LEDs
- 9 Contact Configurable inputs, 3 digital output、 2 high-speed outputs(Electrical isolation)
- 3XRS232C, 2XETHERNET

Controller

- Power supply for FTU and modem
- LBS Motor driving
- Permanent magnet driving
- CAN interface
- Battery charger with test circuit

Control box

- Lead acid battery (12V*2, 7Ah, 12Ah, 35Ah-standard,At least support16h and 10 cycles switch operating)
- Modem ,SMS,GPRS,61850 space
- P54

■ Main functions

Metering

- Galvanic isolation through Aux. CT & Aux. PT
- Secondary of 1000/600/400/200:1、 1000/600/400/200:5 CT ,Up to 200% of rated voltage
- Currents(A,B,C,N), Voltages(A,B,C/R,S,T) : RMS,Phasors, Sequence components, Harmonics
- Power: Apparent(kVA), Active(kW), Reactive(kVar),Power factor
- Energy:4-quadrant metering, import / export active energy, inductive / capacitive reactive energy
- Frequency
- Report value by deadband

Status monitoring

- 9 Contacts input : Open, Closed,Lock, Gas low, Door open, etc.
 - Opto-isolation
 - Delay timers for de-bouncing of each contact input
 - Configurable : Name, Interlock condition, Inverted status
- Controller status
 - battery & battery charger test result
 - External AC power loss
 - Battery low, Battery Fail, Battery overvoltage, Battery Charger Fail, Grounded battery
 - Battery voltage
- Control Status
 - Operator place : Local/Remote
 - Control Lock
 - Recloser On/Off, Protection On/Off, Ground Protection On/Off Function Status
 - Fault indicators, PQM status, Live Line(source, load side), Phase sync., Reclosing status
 - Under voltage status, Under frequency status, Self-diagnostics status, etc.
 - Analog Hi/Low alarm

Control

- 3 contacts output, 2 high-speed outputs
 - Open(Trip), Close, Spares
 - Configurable : Pulse width

BF2 series

- Switch Control
 - Operator place : Remote, Local (Front Panel/PC Tool)
 - Interlocks : Control Lock, Gas low, Mechanical Lock, Current Switch status
 - Close interlock conditions (Selective) : Live load, Phase sync.fail
- SBO (Select before Operate)
 - Secure switch operation
 - SBO timeout (settable)
- Battery Test, Reset Indicators
 - Battery scheduled testing and activation

Protection

- Fault passage indicator
- Over current protection (directional or non-directional)
 - Fast and delayed TC trip elements for phase and earth fault
 - 8 types of built-in TC Curves (IEC, ANSI, Recloser curves)
 - Definite time over-current element
- Negative sequence over-current protection
- Sensitive earth fault detection
- Cold load protection
- Inrush restraints
- Sequence coordination
- Open line detection
- Phase sync. fail detection
- Over voltage/under voltage, under /over frequency
- Auto reclosing (up to 4 shots)
- Loop Automation
- Auto sectionalizing
- 4 setting groups, automatic setting group change depending on power flow

Event/Fault Recording

- SOEs are stored on non-volatile memory with 1ms time-stamp
- Event history buffers are categorized by group
 - Fault Events
 - IO Events
 - System Events
- Fault waveform recording
 - 64 fault waveforms can be stored on non-volatile memory
 - 80 samples/cycle, 15cycles
 - Waveforms are stored as COMTRADE file format through PC maintenance software

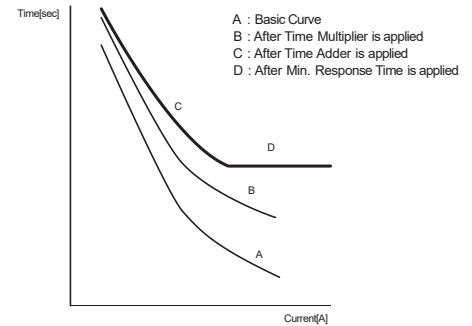

Parameters of TC curve

Communicate

- Subset level 3, DNP over TCP/IP
- IEC60870-5-101, 104
- Index mapping
- Modem control
- Unsolicited data send
- Built-in protocol monitor

Auxiliary functions

- Self-diagnosis
- CAN interface with controller
- PC software for setting & maintenance
- Waveform evaluation software
- Firmware upgradable at site

Example of waveform evaluation

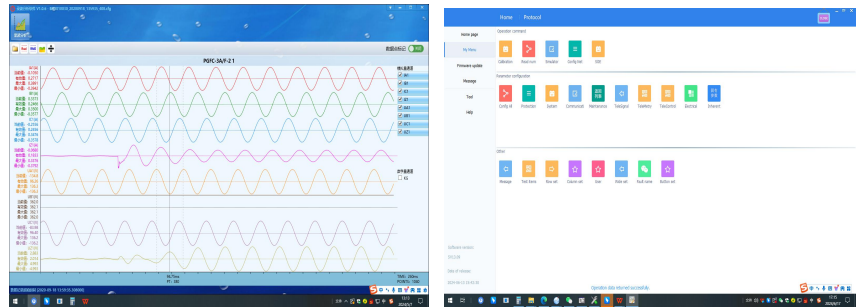

Typical Application

Typical application example of BF2

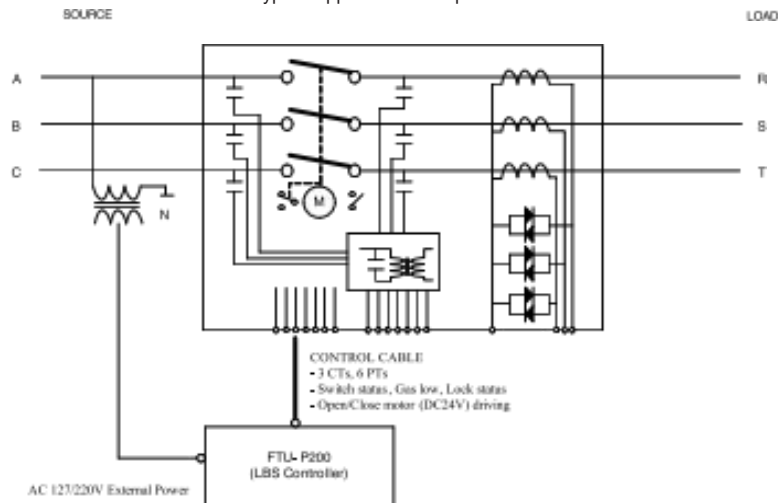

Technical Data

Fault Detection & Protection

Phase Fault

➤ Overcurrent Fun(50-1)	OFF, Trip, Alarm
➤ Pickup Current(50-1)	0-6000(step:0.01A)
➤ Composite voltage Fun	OFF, Only V., Only Vrev., Vrev.&V.
➤ Pickup Negative voltage	0-6000(step:0.01V)
➤ Pickup Phase voltage(50V-1)	0-6000(step:0.01V)
➤ Curve Select(50-1)	ANSI, IEC
➤ Definite Time(50-1)	0-600(step:0.01S)
➤ Overcurrent Direction Fun	OFF, ON
➤ Torque Angle	0-360°(step:1°)

Earth Fault

➤ Ground Overcurrent Fun(50N-1)	OFF, Trip, Alarm
➤ Pickup Current	0-6000(step:0.01A)
➤ Definite Time	0-600(step:0.01S)
➤ Ground Overcurrent Fun(51N-2)	OFF, Trip, Alarm
➤ Pickup Current	0-6000(step:0.01V)
➤ Definite Time	0-600(step:0.01S)
➤ Curve Select	ANSI, IEC

BF2 series

SEF(Sensitive Earth Fault)

➤ Sensitive Earth Fault Func	OFF, Trip, Alarm
➤ 3I0 Pickup current	0-6000A(step:0.01A)
➤ Definite Time	0-600(step:0.01S)
➤ Direction Select	ON, OFF
➤ 3U0 Pickup	0.0-6000(step:0.01V)
➤ Torque Angle	0-360°(step:1°)

Negative Fault

➤ Negative Seq. Current Fun(50Q/51Q)	OFF, Trip, Alarm
➤ Pickup Negative Current	0-6000A(step:0.01A)
➤ Curve Select	ANSI, IEC
➤ Definite Time	0-600(step:0.01S)
➤ Negative Seq. Voltage Fun	OFF, Trip, Alarm
➤ Pickup Voltage	0-99999(step:0.01V)
➤ Negative Seq. Voltage Time	0-600(step:0.01S)

Over Voltage

➤ Over Voltage Fun	OFF, Trip, Alarm
➤ Over Voltage Pickup	0-99999(step:0.01V)
➤ Over Voltage Definite Time	0-600(step:0.01S)

Under Voltage

➤ Over Voltage Fun	OFF, Trip, Alarm
➤ Over Voltage Pickup	0-99999(step:0.01V)
➤ Over Voltage Definite Time	0-600(step:0.01S)

Over frequency

➤ Over frequency Fun	OFF, Trip, Alarm
➤ Over frequency Pickup	0-65(step:0.01HZ)
➤ Over frequency Definite Time	0-600(step:0.01S)

Under frequency

➤ Under frequency Fun	OFF, Trip, Alarm
➤ Under frequency Pickup	0-65(step:0.01HZ)
➤ Under frequency Definite Time	0-600(step:0.01S)

Sync. Check

➤ Close InterLock	ON, OFF
➤ Synchronization Check	ON, OFF
➤ Voltage difference	0-99999(step:0.01V)
➤ Angle difference	0-360(step:1°)
➤ Compensation Angle	0-360(step:1°)

Inrush

➤ Inrush Restraint	ON, OFF
➤ Startup Current	0-6000(step:0.01A)
➤ Harmonic Component	5-100(step:0.1%)
➤ Inrush Time	0-600(step:0.01S)

Phase Reclosing

➤ Phase Reclose Func(79P)	ON, OFF
➤ Phase Reclose Count	1-4
➤ Reclose 1st Active	ON, OFF
➤ Reclose 2st Active	ON, OFF
➤ Reclose 3st Active	ON, OFF
➤ Reclose 4st Active	ON, OFF
➤ Reclose Time 1st	0-600(step:0.01S)
➤ Reclose Time 2st	0-600(step:0.01S)
➤ Reclose Time 3st	0-600(step:0.01S)
➤ Reclose Time 4st	0-600(step:0.01S)
➤ Phase Reclose Reset Time	5-600(step:0.01S)
➤ Single Shot Oper	ON, OFF

Earth Reclosing

➤ EarthReclose Func(79N)	ON, OFF
➤ EarthReclose Count	1-4
➤ Reclose Time 1st	0-600(step:0.01S)
➤ Reclose Time 2st	0-600(step:0.01S)
➤ Reclose Time 3st	0-600(step:0.01S)
➤ Reclose Time 4st	0-600(step:0.01S)
➤ Phase Reclose Reset Time	5-600(step:0.01S)
➤ Single Shot Oper	ON, OFF

Loop Automation

➤ Automatic Closing time(X)	0-600(step:0.01S)
➤ Confirmation Time for closing(Y)	0-600(step:0.01S)
➤ Confirmation Time for voltage loss(Z)	0-600(step:0.01S)
➤ Automatic Earth Fault Func	ON, OFF
➤ 3U0 Pickup Voltage	0-99999(step:0.01V)
➤ Automatic Phase Fault Func	ON, OFF
➤ Phase Pickup Current	0-6000(step:0.01A)
➤ Blocking Time After Closing	0-600(step:0.01S)

Cold Load Pick Up

➤ Cold Load Fun	ON, OFF
➤ Phase Pickup Multiplier	1-10(step:1)
➤ Ground Pickup Multiplier	1-10(step:1)
➤ Phase Ground Duration	1-9999(step:0.01S)

Auto Section

>Phase Count Func	ON,OFF
>Phase Count	1-4
>Phase Count Pickup Current	0-6000(step:0.01A)
>Phase Count Return Time	0-600(step:0.01S)
>Phase Count Definite Time	0-600(step:0.01S)
>Phase Count Reset Time	0-600(step:0.01S)
>Phase Count Trip Time	0-600(step:0.01S)
>Earth Count Func	ON,OFF
>Earth Count	1-4
>Earth Count Pickup Current	0-6000(step:0.01A)
>Earth Count Return Time	0-600(step:0.01S)
>Earth Count Definite Time	0-600(step:0.01S)
>Earth Count Reset Time	0-600(step:0.01S)
>Earth Count Trip Time	0-600(step:0.01S)

System Configuration

>Change Password	0-99999	Password
>Phase Rotate Func	ON,OFF	
>Power Direction Func	ON,OFF	Group setting
>Current Group	Group 0,Group 1, Group 2,Group 3	
>Reverse Group	Group 0,Group 1, Group 2,Group 3	
>Display Switching	Secondary,Primary	Power
>Line Voltage On Level	30- 99999(step:0.01V)	Monitoring
>Line Voltage Loss Level	10- 99999(step:0.01V)	
>Waveform Trigger	ON,OFF	Waveform
>Realy Control Func	ON,OFF	Protection
>Protection function control	ON,OFF	Blocking
>Store Interval Time	0-99999(step:1S)	Demand Interval
>DI01 Programme	OPEN,	Configurable
>DI02 Programme	CLOSE,	digital inputs
>DI02 Programme	Motor Close,	
>DI03 Programme	Motor Open,	
>DI03 Programme	Ext. Trip,	
>DI04 Programme	Ext. Close,	
>DI05 Programme	Lock Open,	
>DI06 Programme	GAS low Open,	
>DI06 Programme	GAS low Close,	
>DI07 Programme	BAK,	
>DI08 Programme	Lock,	
>DI09 Programme	Pretect	

Broken Conductor

>Open Line Func	OFF,Trip,Alarm
>Open Line Pickup Voltage	0-99999(step:0.01V)
>Open Line Definite Time	0-600(step:0.01S)

Breaker Failure

>Breaker Failuer Func	OFF, Trip,Alarm
>Breaker Failuer Definite Time	0-600(step:0.01S)

Switch Control

>Permanent magnet Trip undervoltage	60-300(step:0.1V)
>Permanent magnet Close undervoltage	60-300(step:0.1V)
>Trip Hold Max Time	0-2000(step:1ms)
>Close Hold Max Time	0-2000(step:1ms)
>Moto Storage Time Max	1000-99999(step:1ms)

Battery Alarm

>Battery Low Funtion	ON,OFF
>Battery Low Voltage	15-50(step:0.1V)
>Battery Low Definite Time	1000-99999(step:1ms)

BF2 series

Maintenance Configuration

Protocol telemetry coefficient

➤Ia,Ib,Ic Coefficient	0-99999(step:1)
➤I0 Coefficient	0-99999(step:1)
➤Ua,Ub,Uc,Ur,Us,Ut Coefficient	0-99999(step:1)
➤U1,U2 Coefficient	0-99999(step:1)
➤U0 Coefficient	0-99999(step:1)
➤DC Coefficient	0-99999(step:1)
➤P,Q,S Coefficient	0-99999(step:1)
➤COS Coefficient	0-99999(step:1)

AC Rating

➤PTs Primary	1~40 kV (step : 0.01 kV)
➤PTs Secondary	1-1000V(step : 0.01 V)
➤PT Primary	1~40 kV (step : 0.01 kV)
➤PT Secondary	1-1000V(step : 0.01 V)
➤U0 Primary	1~40 kV (step : 0.01 kV)
➤U0 Secondary	1-220V(step : 0.01 V)
➤CT Primary	10-6000A(step : 1A)
➤CT Secondary	1-5A(step : 1A)
➤CT0 Primary	10-6000A(step : 1A)
➤CT0 Secondary	1-5A(step : 1A)

Protocol telemetry Unsolicited data

➤Ia,Ib,Ic Unsolicited data	0-600(step:1A)
➤I0 Unsolicited data	0-600(step:1A)
➤Ua,Ub,Uc,Ur,Us,Ut Unsolicited data	0-10000(step:1V)
➤U0 Unsolicited data	0-10000(step:1V)
➤DC Unsolicited data	0-24(step:1V)
➤P,Q,S Unsolicited data	0-99999(step:1W)
➤COS Unsolicited data	0-1(step:0.001)

Masking value

➤Ia,Ib,Ic Masking value	0-1000(step:0.001A)
➤I0 Masking value	0-1000(step:0.001A)
➤Ua,Ub,Uc,Ur,Us,Ut Masking value	0-10000(step:0.01V)
➤U0 Masking value	0-10000(step:0.01V)

Automatic Battery Check

➤Battery Test Interval Day	1-360(step:1day)
➤Battery Test Interval Hour	0-23(step:1h)
➤Battery Test Time	10-6000(step:1min)

Switch Control

➤Trip(Open) Max Time	5-99999(step:1ms)
➤Close Max Time	5-99999(step:1ms)

Communication Configuration

Port Configuration

➤COM1 Protocol Select	IEC101,IEC104,modbus,
➤COM2 Protocol Select	DNP3.0(default:IEC101)
➤COM3 Protocol Select	
➤Net1 Protocol Select	IEC101,IEC104,DNP3.0(default:IEC104)
➤Net2 Protocol Select	
➤Ethernet port number	0-65535(default:2404)
➤COM1 Baud Rate	9600-115200(default:115200)
➤COM2 Baud Rate	
➤COM3 Baud Rate	
➤COM1 Parity	OFF,Even,Odd(default:OFF)
➤COM2 Parity	
➤COM3 Parity	

IEC101/IEC104/DNP3.0 Configuration

➤IEC101/IEC104/DNP3.0 MSP Start Address	0-65535
➤IEC101/IEC104/DNP3.0 MDP Start Address	
➤IEC101/IEC104/DNP3.0 MME Start Address	
➤IEC101/IEC104/DNP3.0 CSC Start Address	
➤IEC101/IEC104/DNP3.0 MME Ti Type	Hex,Float,Bin
➤IEC101/IEC104/DNP3.0 CSC Mode Select	Singlebit,Doublebit
➤IEC101 Protocol Cots. Size	1-2
➤IEC101 Protocol Obj Size	1-2
➤IEC101 Protocol link Size	1-2
➤IEC104 Protocol Cots.Size	1-2
➤IEC104 Protocol Obj. Size	2-3
➤IEC104 Protocol Link Size	1-2
➤IEC101/IEC104/DNP3.0 CSC Check Overtime	10-60000(step:1S)
➤Unsolicited data Sending Definite Time	0-60000(step:1ms)
➤IEC101/IEC104/DNP3.0 Commande Selection/Execution	SBO,DO

■ Measurements

Current

➤RMS (A) & Phase Angle (Deg)	Ia, Ib, Ic, In, I1, I2
➤ True RMS (A)	Ia, Ib, Ic
➤ Accuracy	±0.005%
➤ Reading Range	0.010-50A(Secondary)

Power

➤ Active Power(kW)	Pa, Pb, Pc, P(total)
➤ Reactive Power(kVAR)	Qa, Qb, Qc, P(total)
➤ Apparent Power(kVA)	Sa, Sb, Sc, P(total)
➤ Power Factor	cos
➤ Accuracy	3%

■ HMI

LCD

➤ Screen RAM	20characters * 8 lines, LED backlight
--------------	---------------------------------------

LED

➤ Opened	Switching Off
➤ Closed	Switching On
➤ A Phase Open	Phase A state
➤ B Phase Open	Phase B state
➤ C Phase Open	Phase C state
➤ Self-Check	CPU is work
➤ DC Power	DC power suppl
➤ Earth Fault	The line has ground fault
➤ Phase Fault	There is a short circuit fault in the line
➤ Lockout	Unable to close automatically
➤ Comm.	The connection with the main station is normal
➤ Batt Fault	Low battery voltage
➤ Remote	Remote State
➤ Local	Local State
➤ Neg.Volt. ALARM	Negative sequence overvoltage

BUTTON

➤ Number keyboard	Parameter modification and confirmation
➤ START	Startup of FTU
➤ RESET	Fault or locked manual reset

AC Voltage

➤RMS (V) & Phase Angle (Deg)	Va, Vb, Vc, Vr, Vs, Vt, Vab, Vbc, Vca, Vrs, Vst, Vtr
➤ Sequence Component	Vo, V1, V2
➤ Accuracy	±0.005%
➤ True RMS (Source & Load)	Va, Vb, Vc, Vr, Vs, Vt
➤ Reading Range	0.05-5V(Secondary)

Frequency

➤ Measuring range	45~65 Hz
➤ Accuracy	±0.02 Hz

Energy

➤ Accuracy	±4%
------------	-----

DC Voltage

➤ Battery voltage	0-65V
➤ Capacitance	0-400V
➤ Accuracy	±1%

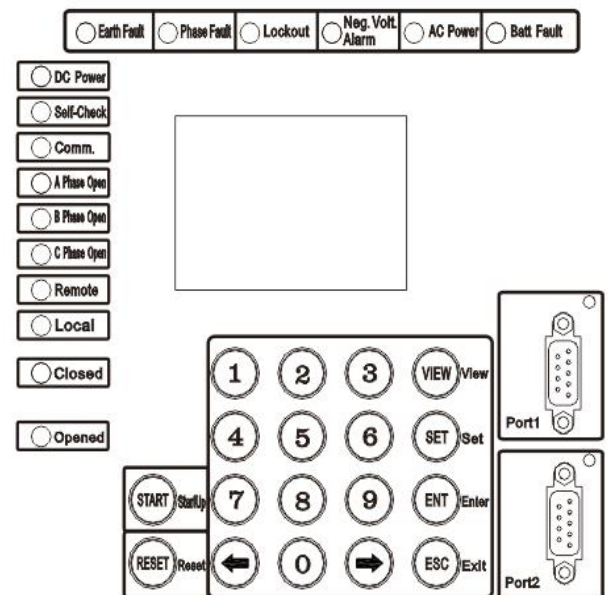

General Specifications

Power module

➤ Input voltage range	AC220V±20%(50 or 60 Hz)
➤ Onput voltage range	27.0V~27.5V
➤ Battery Charging Voltage	27.0V~27.5V
➤ Battery charging current	0.6-0.8A
➤ Battery discharge cut-off	20.5-21.5V
➤ Battery activation completion	22.5-23V
➤ Battery undervoltage alarm	22-22.5V

LBS or Recloser Interface

Basically, BF2 has three sockets at the bottom of the casing to control the cables Including 3 current CT analog inputs, 6 PT analog inputs for source side (A/B/C) and load side (R/S/T) voltage, switch input status monitoring, and digital outputs for control. This original interface configuration can be customized for external CT/PT connections.

➤ Humidity	≤95 % RH
➤ Altitude	up to 3000 m
➤ Control Box (Gross) Weights	37KG

Battery (Lead Acid)

➤ Output, Capacity	DC12V * 2, 7 Ah (standard)
➤ Run Time	over 12 hrs without AC power
➤ Switch Control	over 100 times without AC power

FTU Power Supply

➤ Supply	DC 24V
----------	--------

Modem Power Supply

➤ Supply	6DC-36V
----------	---------

Modem Power Supply

➤ Enclosure Material	Stainless Steel, 2t (IP54)
----------------------	----------------------------

Communication Interface

■ RS 232C Port #1/#2/#3

➤ Optical isolation	
➤ ESD/Transient noise protection	
➤ Protocols	DNP 3.0 (Level 3) or IEC60870-5-101 or IEC60870-5-104
➤ Baud Rate	9600-115200bps
➤ Connector Type	Port1 DB9 Female, Port 2 is mode pin,Port 3 is mode pin
➤ Maintenance Port	YSE

■ TCP/IP

➤ 10/100 BASE-T	
➤ Protocols	DNP 3.0 (Level 3) or IEC60870-5-101 or IEC60870-5-104
➤ Connector Type	2XRJ45
➤ Maintenance Port	YSE

BF2 series

Outline & Dimension

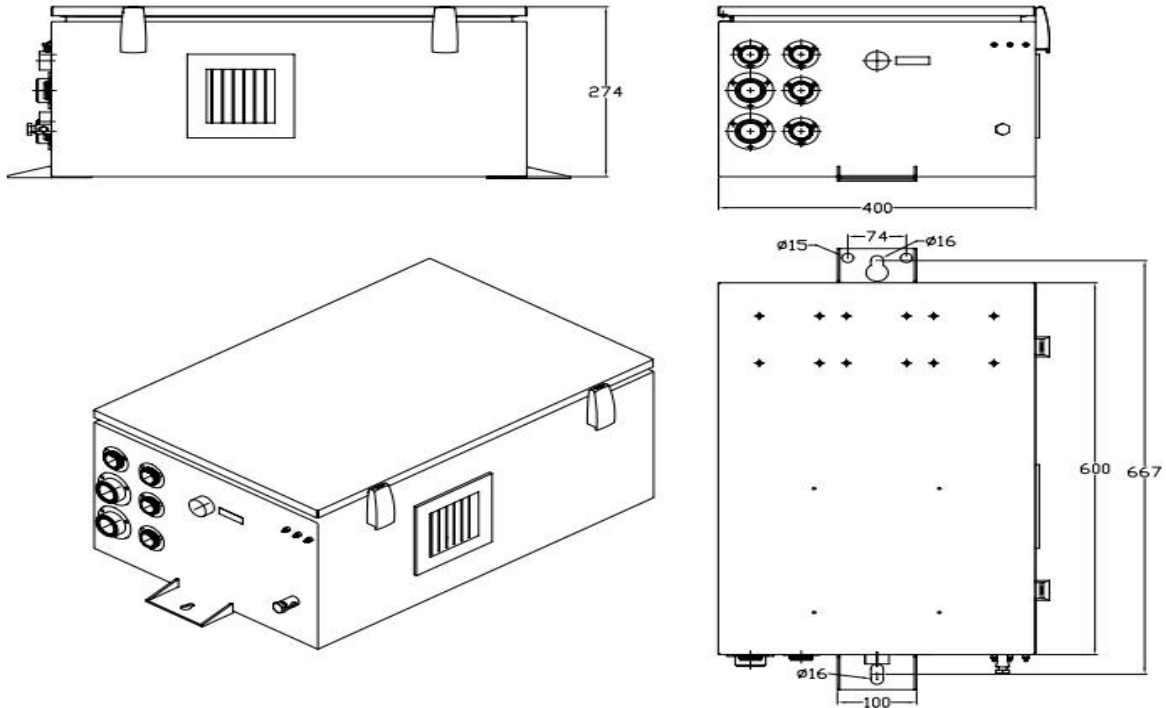

Enclosure Dimensional Drawings

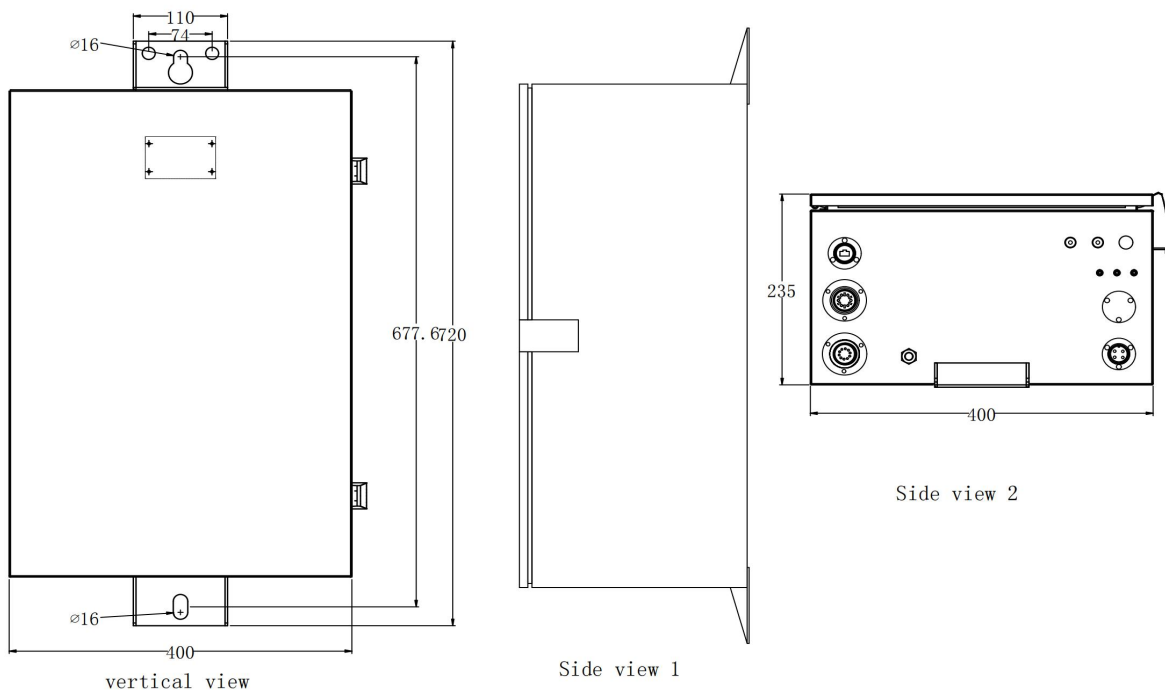

BF2 series

FTU Interface Connectors



Construction

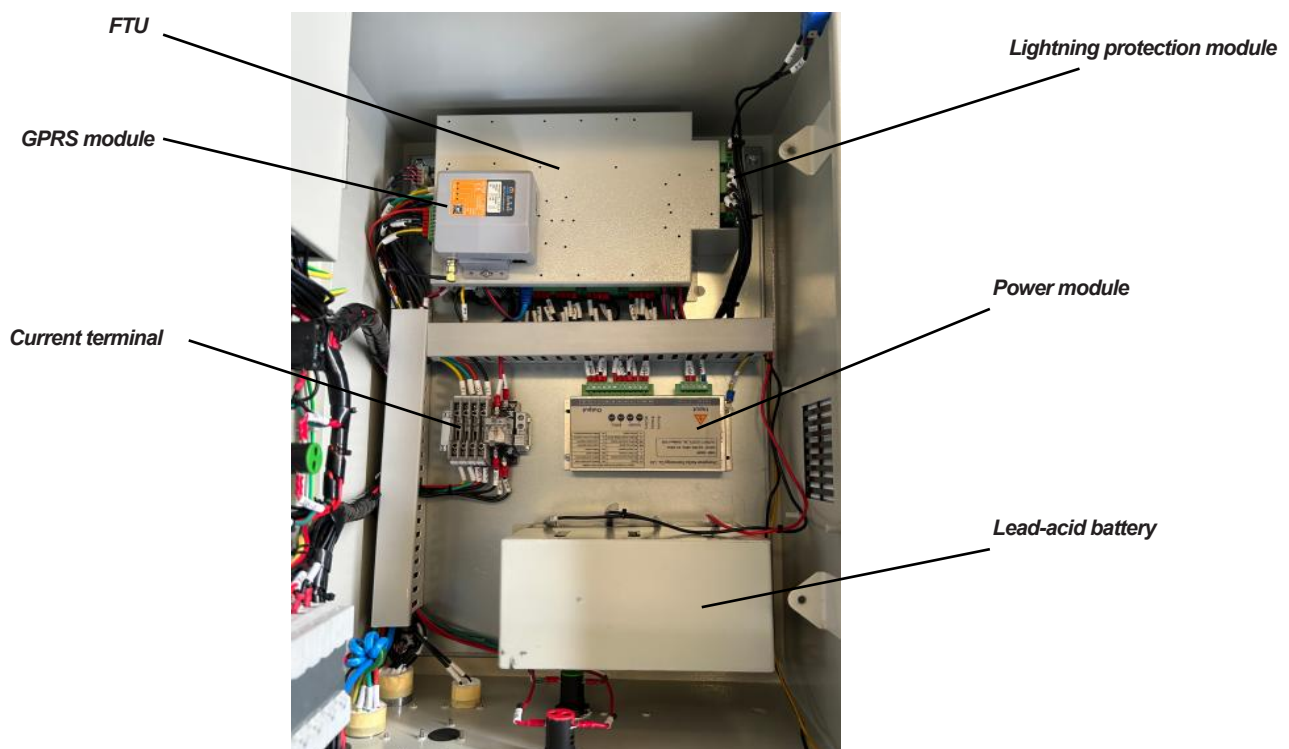

BF2 series

External Connections

BF2

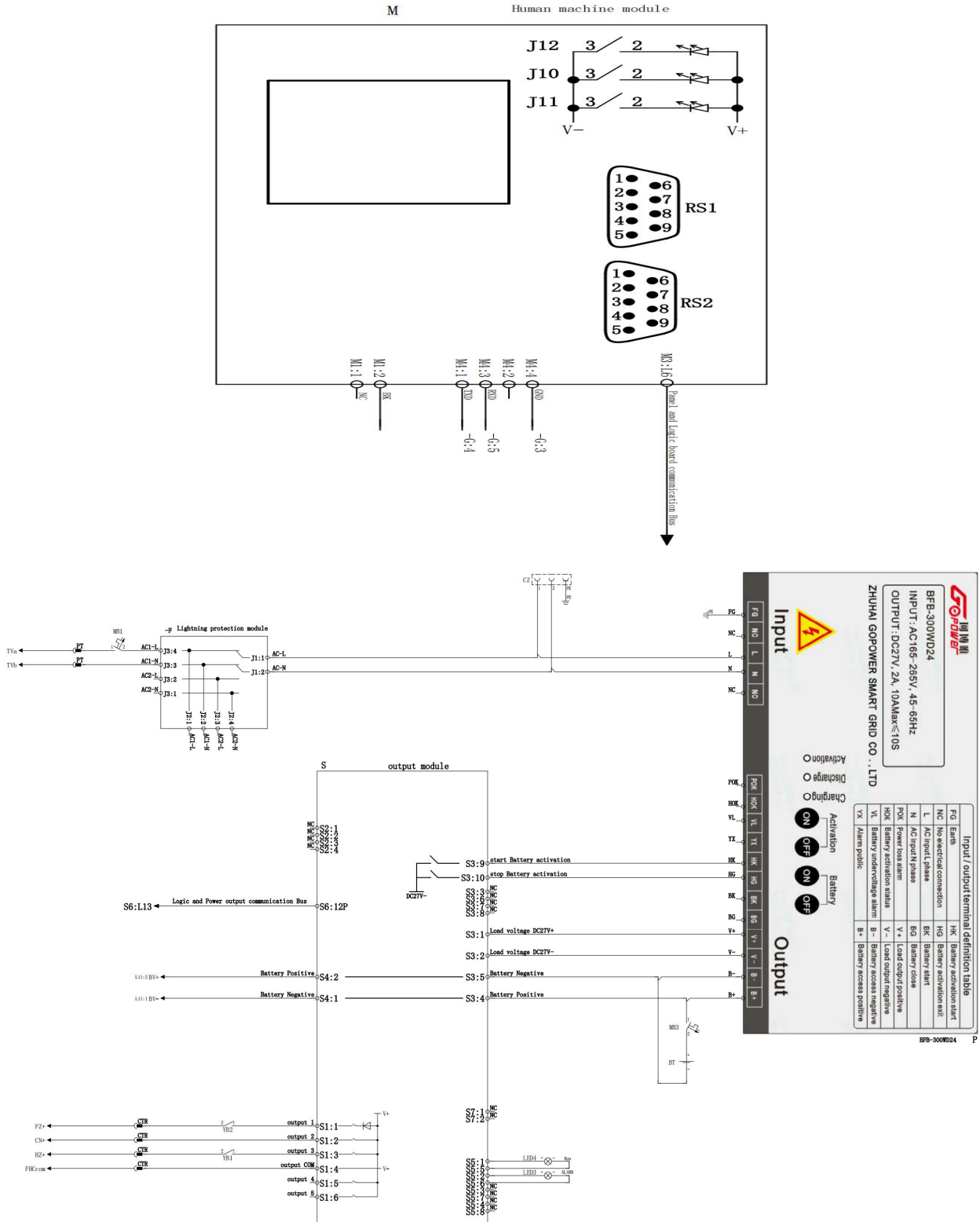

BF2 series

External Connections

■ BF2

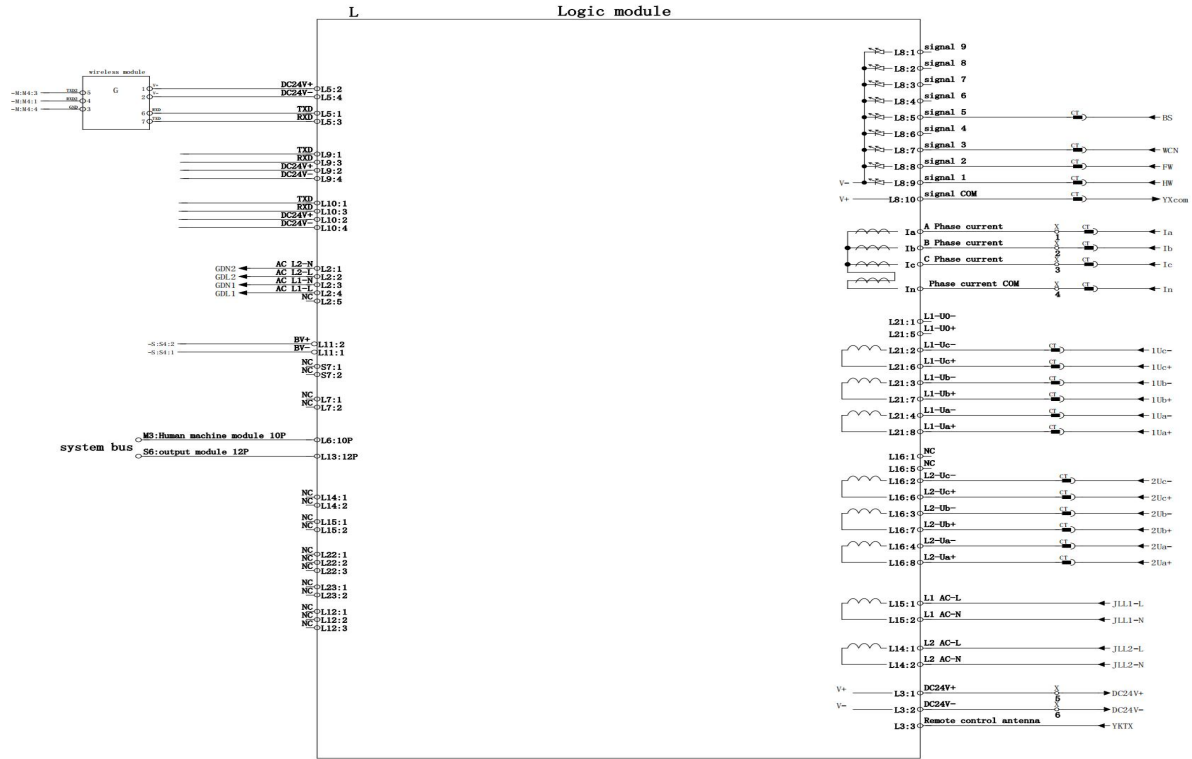

X connecting terminal			4HC 4-core aviation plug			6HC 6-core aviation plug			19HC 19-core aviation plug		
SN	define	code	SN	define	code	SN	define	code	SN	define	code
1	A Phase current	Ia	1	PT1:A Phase AC220V-L	TVa	1	A Phase current	Ia	1	open signal	FW
2	B Phase current	Ib	2	NC		2	B Phase current	Ib	2	Spring Discharged	WCN
3	C Phase current	Ic	3	PT1:B Phase AC220V-N	TVb	3	C Phase current	Ic	3	Manual locking signal	BS
4	Phase current com	In	4	NC		4	Phase current com	In	4	close signal	HW
5	Output DC24V+	ODC+				5	NC		5	signal com	YXCOM
6	Output DC24V-	ODC-				6	NC		6	open output DC24V +	FZ+
									7	output com DC24V -	FHCcom
									8	close output DC24V +	HZ+
									9	output com DC24V -	FHCcom
									10	save output DC24V +	CN+
									11	output com DC24V -	FHCcom
									12	A Phase voltage +	Ua
									13	Phase voltage com	Ucom
									14	B Phase voltage +	Ub
									15	C Phase voltage +	Uc
									16	A Phase voltage	Ur
									17	B Phase voltage	Us
									18	C Phase voltage	Ut
									19	NC	

Zhuhai Gopower Smart Grid Co., Ltd.

Head Office & Factory

**Address : FLOOR 2 BUILDING 3,NO.2007 MINGZHU SOUTH
RD,QIANSHAN,ZHUHAI,GUANGDONG,CHINA**

Mobil:+86-18666114655

Tell:+86-0756-6102222

**Email: 13902532738@139.com, zhgopower@163.com
<https://www.zhgopower.com/>**